

LZ95B25

Subcarrier Generator LSI for CCD

DESCRIPTION

The LZ95B25 is a CMOS subcarrier signal generator LSI which provides subcarrier pulses for color video camera, in combination with the SSG LSI (LZ95D52/M)

FEATURES

- . Switchable between NTSC, PAL and SECAM systems
- . Included phase comparator circuit
- Single + 5 V power supply
- Package : 18-pin MFP(MFPO1 8-P)

PIN CONNECTIONS

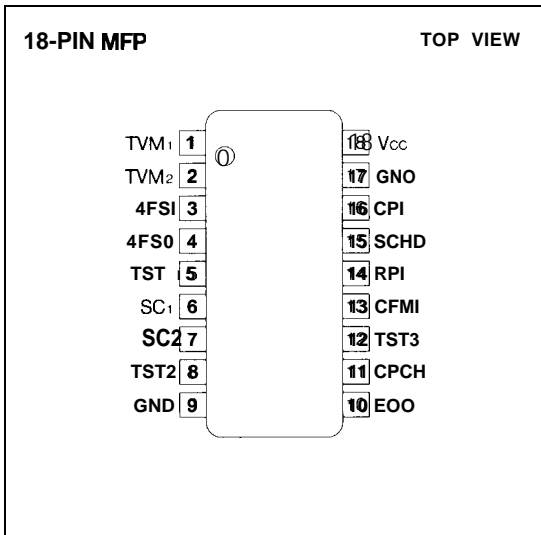

3 CCD PERIPHERALS

BLOCK DIAGRAM

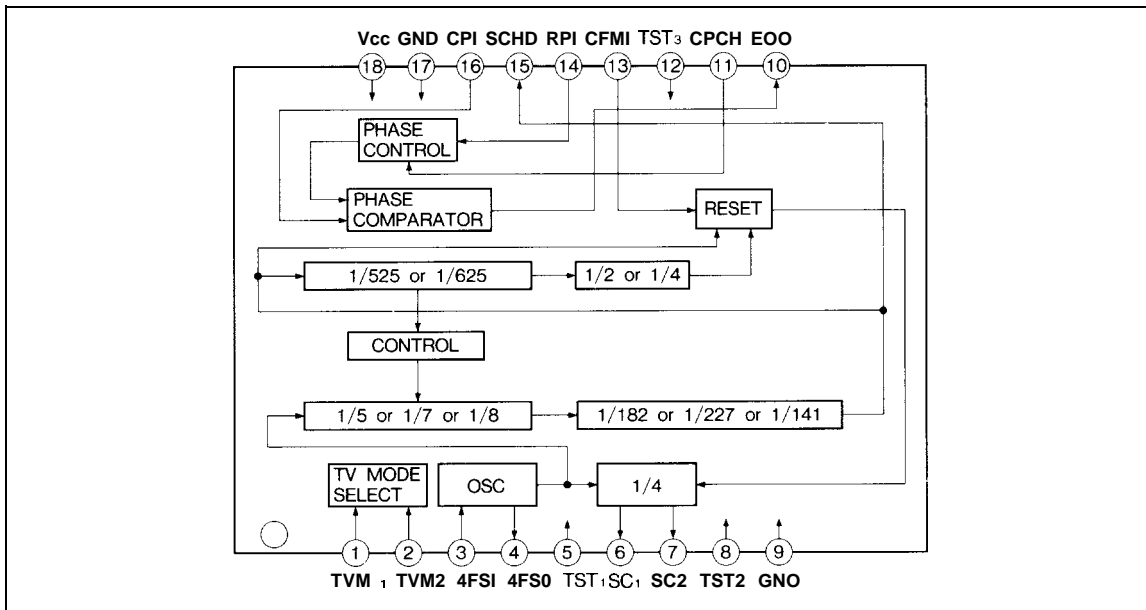

ABSOLUTE MAXIMUM RATINGS

PARAMETER	SYMBOL	RATING	UNIT
Supply voltage	V _{CC}	-0.3 to 7.0	v
Input voltage	V _I	-0.3 to V _{CC} + 0.3	v
Output voltage	V _O	-0.3 to V _{CC} + 0.3	v
Operating temperature	T _{opr}	-20 to +70	°c
Storage temperature	T _{stg}	-55 to +150	°c

DC CHARACTERISTICS





(V_{CC} = +5 V ± 10%, T_a = -10 to +70°C)

PARAMETER	SYMBOL	CONDITIONS	MIN.	TYP.	MAX.	UNIT	NOTE
Input Low voltage	V _{IL}				1.5	v	1
Input High voltage	V _{IH}		3.5			v	
Input Low current	I _{IL1}	V _I = 0 v			1.0	μA	2
	I _{IL2}	V _I = 0 v	8.0		60	μA	3
Input High current	I _{IH1}	V _I = V _{CC}			1.0	μA	4
	I _{IH2}	V _I = V _{CC}	8.0		60	μA	5
Output High voltage	V _{OH1}	I _{OH} = -2 mA	4.0			v	6
	V _{OH2}	I _{OH} = -1 mA	4.0			v	7
	V _{OH3}	I _{OH} = -6 mA	4.0			v	8
Output Low voltage	V _{OL1}	I _{OL} = 4 mA			0.4	v	6
	V _{OL2}	I _{OL} = 2 mA			0.4	v	7
	V _{OL3}	I _{OL} = 12 mA			0.4	v	8
Leak output current	I _{oz}	High-Z			1.0	μA	

NOTES :

1. Applied to inputs (IC, ICU, OSC1).
2. Applied to inputs (ICD, OSC1).
3. Applied to input (ICU).
4. Applied to inputs (ICU, OSC1).
5. Applied to input (ICD).
6. Applied to outputs (O, OSCO).
7. Applied to output (O2M).
8. Applied to tri-state output (EOO).

PIN DESCRIPTION

PIN NO.	SYMBOL	I/O	POLARITY	PIN NAME	FUNCTION															
1	TVM1	Icu	—	TV mode 1	These input pins to select TV standards. <table border="1"> <thead> <tr> <th>TV mode</th> <th>NTSC</th> <th>PAL</th> <th>no-use</th> <th>SECAM</th> </tr> </thead> <tbody> <tr> <td>TVM1</td> <td>L</td> <td>L</td> <td>H or open</td> <td>H or open</td> </tr> <tr> <td>TVM2</td> <td>L</td> <td>H or open</td> <td>L</td> <td>H or open</td> </tr> </tbody> </table>	TV mode	NTSC	PAL	no-use	SECAM	TVM1	L	L	H or open	H or open	TVM2	L	H or open	L	H or open
TV mode	NTSC	PAL	no-use	SECAM																
TVM1	L	L	H or open	H or open																
TVM2	L	H or open	L	H or open																
2	TVM2	ICU	—	TV mode 2																
3	4FSI	OSCI		Clock input	An input pin for the signal 4 times the color sub-carrier frequency. At NTSC mode : 14.31818 MHz At PAL mode : 17.734475 MHz At SECAM mode : 17.625 MHz															
4	4FS0	OSCO		Clock output	The output is the inverse 4FSI (pin 4).															
5	TST1	ICD	—	Test pin 1	A test pin, Set open or to L level in the Normal mode,															
6	SC1	02M		Subcarrier output 1	An output pin for color subcarrier. The frequency of the signals is 1/4 the 4FSI (pin 3). The signal is reset by color frame pulse CFMI (pin 13).															
7	SC2	02M		Subcarrier output 2	An output pin for color subcarrier. When the phase of SC1 (pin 4) is 180 degree, the phase of SC2 is 80 degree in NTSC mode; in PAL mode, the phase of SC2 is 90 degree when LSW (SSG-LSI) is L level and 270 degree when LSW is H level. The SC 2 is same as the phase of SC 1 in SECAM mode.															
8	TST2	ICD	—	Test pin 2	A test pin. Set open or to L level in the Normal mode.															
9	GND	—	—	Ground	A grounding pin.															
10	EOO	TO	—	Phase comparator output	Phase comparator output for input signals RPI (pin 14) and CPI (pin 16). When CPI is advanced, output is Low level. When CPI is delayed, output is High level. When phases are equal, the terminal impedance is High. Phase comparator compares rising edge of CPI.															
11	CPCH	ICD	—	Polarity select input	The CPCH input pin switches the polarity of RPI (pin 14). When CPCH is L level, phase comparator compares rising edge of RPI. When CPCH is H level, phase comparator compares falling edge of RPI.															
12	TST3	ICD	—	Test pin 3	A test pin. Set open or to L level in the Normal mode.															
13	CFMI	ICD	—	Color frame input	An input pin for color frame signal; Connect to CFMO (SSG-LSI).															

PIN NO.	SYMBOL	I/O	POLARITY	PIN NAME	FUNCTION
14	RPI	ICD	—	Horizontal comparison input	An input pin for the reference horizontal signal to the phase comparator. Connect to HD (SSG-LSI), when comparator is used. The polarity of RPI selects with CPCH (pin 11),
15	SCHD	O	—	Subcarrier HD	A horizontal synchronous pulse obtained by dividing 4FSI (pin 3). At NTSC mode : dividing into 1/910 4FSI. At PAL mode : dividing into 1/1 135 4FSI ordinarily and dividing into 1/1 137 4FSI during one horizontal period within the V blanking. At SECAM mode : dividing into 1/1 128 4FSI.
16	CPI	ICD	—	Horizontal comparison input	An input pin for comparison horizontal signal to the phase comparator. Connect to SCHD (pin 15) when comparator is used,
17	GND	—	—	Ground	A grounding pin.
18	Vcc	—	·	Power supply	Supply +5 V power.

ICU : Input pin (CMOS level with built-in pull-up resistor).

ICD : Input pin (CMOS level with built-in pull-up resistor).

O : Output pin,

O2M : Output pin.

TO : Output pin (tri-state output).

OSCI : Input pin for oscillation.

OSCO : Output pin for oscillation.

TIMING DIAGRAM

PULSE TIMING < NTSC >

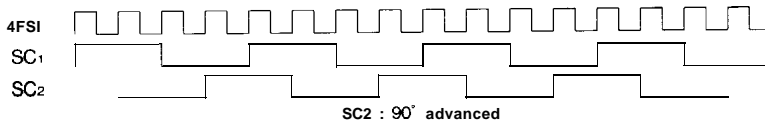

PULSE TIMING < PAL >

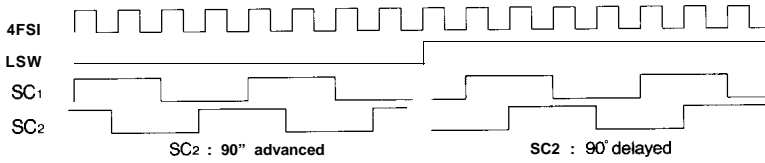

PULSE TIMING < SECAM >

